



Augenti[®]
LIGHTING



STEMS



ELEGANCE
IS WHEN
AN OBJECT
CORRESPONDS
TO ITS CONCEPT

STEM collection

Un sottile stelo, leggero e discreto, un concept volto a prediligere l'essenza della luce e la pulizia del design. **Stem** si presenta così: una collezione di paletti da giardino **contraddistinti da un sottile anello di luce**, pensati per favorire l'effetto scenografico, la morbidezza, e l'esclusività degli spazi. Il suo utilizzo ideale è la collocazione in zone verdi, cespugli, outdoor living intimi ed accoglienti che evocano il calore di casa, fascino ed eleganza. Adatti anche a creare suggestivi percorsi dedicati ad impreziosire ingressi e vialetti.

Le **tre altezze** e la possibilità di installare **Stem con base, cassaforma interrata o picchetto**, permettono di dare vita a movimenti di luce giocosi e molto attuali. La sua luminescenza diffusa e fluida, quasi fosse un'aura rarefatta, si fonde all'ambiente naturalistico con armonia e delicatezza, con il fine di costruire e valorizzare una scena dando forma ad una visione, senza imporsi su di essa. Proprio per avvantaggiare il principio di fusione con l'ambiente, **Stem è proposto in 9 colori di verniciatura**, agevolando le esigenze del committente, dell'architetto paesaggista o del lighting designer. A completamento della collezione vi è anche la **versione a parete**, un'applique a disco che ricrea a muro la stessa avvolgente atmosfera di luce.

Stem, il fascino del concetto.

A thin **stem**, light and discreet, a concept aimed at favoring the essence of the light and cleaning of the design. **Stem** looks like this: a collection of garden stakes **distinguished by a thin ring of light**, designed to enhance the spectacular effect, the softness, and the exclusivity of the spaces. Its ideal use is the placement in green areas, bushes, intimate and welcoming outdoor living areas that evoke the warmth of home, charm and elegance. Also suitable for creating suggestive paths dedicated to embellishing entrances and walkways.

The **three heights** and the possibility of installing **Stem with base, underground recessed box or spike**, allow you to create playful and very modern movements of light. Its diffused and fluid luminescence, as if it was a rarefied aura, blends into the naturalistic environment with harmony and delicacy, with the aim to build and enhance a scene by giving shape to a vision, without imposing itself on it. Precisely to favor the principle of fusion with the environment, **Stem is offered in 9 paint colors**, helping the needs of the client, the landscape architect or the lighting designer. To complete the collection, there is also the **wall version**, a disc-shaped applique that recreates the same enveloping atmosphere of light on the wall.

Stem, the charm of the concept.

Une tige fine, légère et discrète, un concept visant à privilégier l'essence du design léger et épuré. **Stem** ressemble à ceci : une collection de piquets de jardin **qui se distingue par un fin anneau de lumière**, conçue pour rehausser l'effet scénographique, la douceur et l'exclusivité des espaces. Son utilisation idéale est le placement dans des espaces verts, des buissons, des espaces de vie extérieurs intimes et accueillants qui évoquent la chaleur de la maison, le charme et l'élégance. Convient également pour créer des chemins suggestifs dédiés à l'embellissement des entrées et des chemins.

Les trois hauteurs et la possibilité d'installer **Stem avec socle, coffrage enterré ou piquet**, permettent de créer des mouvements de lumière ludiques et très actuels. Sa luminescence diffuse et fluide, comme s'il s'agissait d'une aura rarefiée, se fond dans l'environnement naturaliste avec harmonie et délicatesse, dans le but de construire et de mettre en valeur une scène en donnant forme à une vision, sans s'imposer à elle. Précisément pour bénéficier du principe de fusion avec l'environnement, **Stem est proposé en 9 couleurs de peinture**, facilitant les besoins du client, de l'architecte paysagiste ou du concepteur d'éclairage. Pour compléter la collection, il existe également la **version murale**, une applique disque qui recrée la même atmosphère enveloppante de lumière sur le mur.

Stem, le charme du concept.



STEM
collection

bollard

STEM



Fixture Specifications

Protection . IP 65 - IK 08

Body . Anticorodal turning aluminum 6000 Serie, for greater corrosion resistance

Screen . Opal Polycarbonate

Seals . EPDM rubber

Screws . Stainless steel A2

Paint / Finishing . Anti-corrosive UV stabilised polyester powder

Finishes

New Color

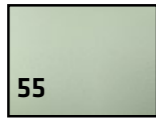

55
GREEN
COOL MINT
RAL 6019

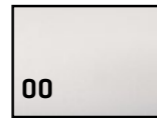

00
PURE WHITE
RAL 9016

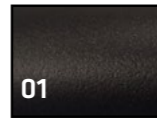

01
BLACK
RAL 9005



10
WHITE
RAL 9010

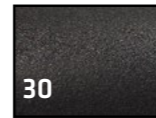

30
ANTHRACITE

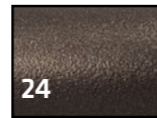

24
BRONZE

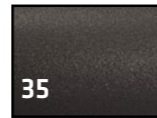

35
SLATE GREY

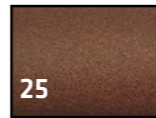

25
RUST



40
GREY
RAL 9006

Technical Data

EMISSIONE DIFFUSA 360° - DIFFUSE EMISSION 360°

3000K - 4000K

Versione in Tensione - Constant voltage (Vdc)

11 W con DRIVER REMOTO 24Vdc - 11 W REMOTE DRIVER 24Vdc

Specifications

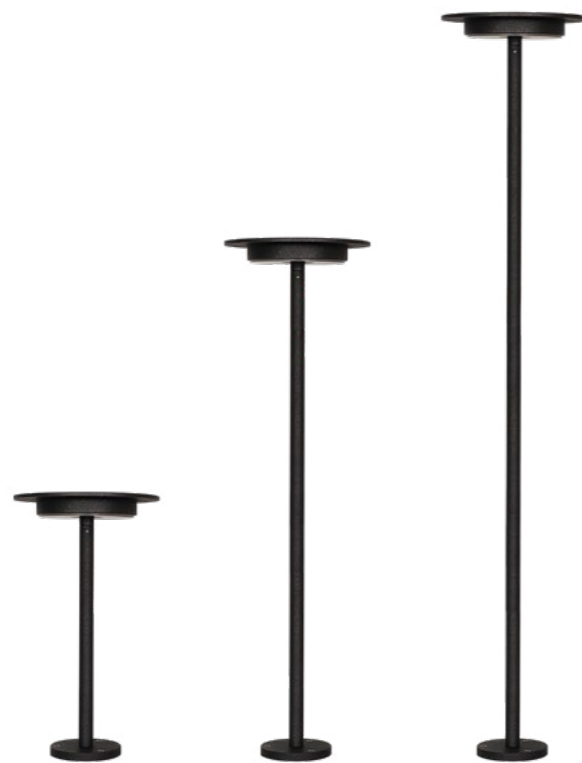

Paletti / Small Poles / Poteaux



STEM BOLLARD

STEM BOLLARD

led WHITE

SMALL POLES

STANDARD version

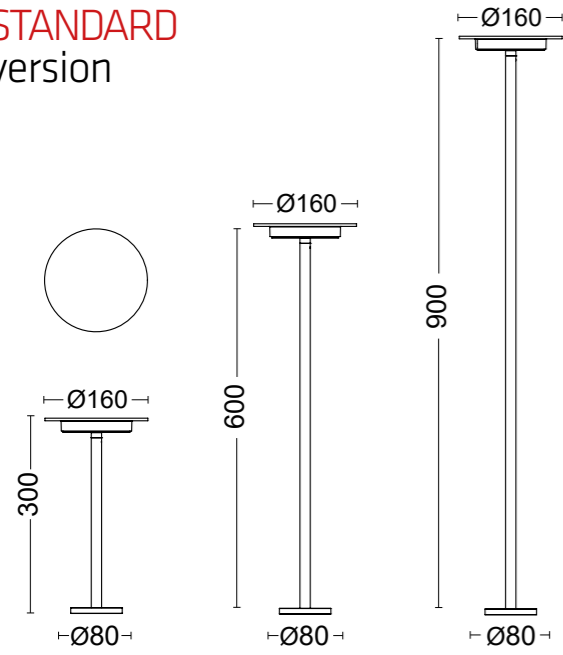

Quote espresse in millimetri "mm"
Share expressed in millimeters "mm"

version with SPIKE ACCESSORY

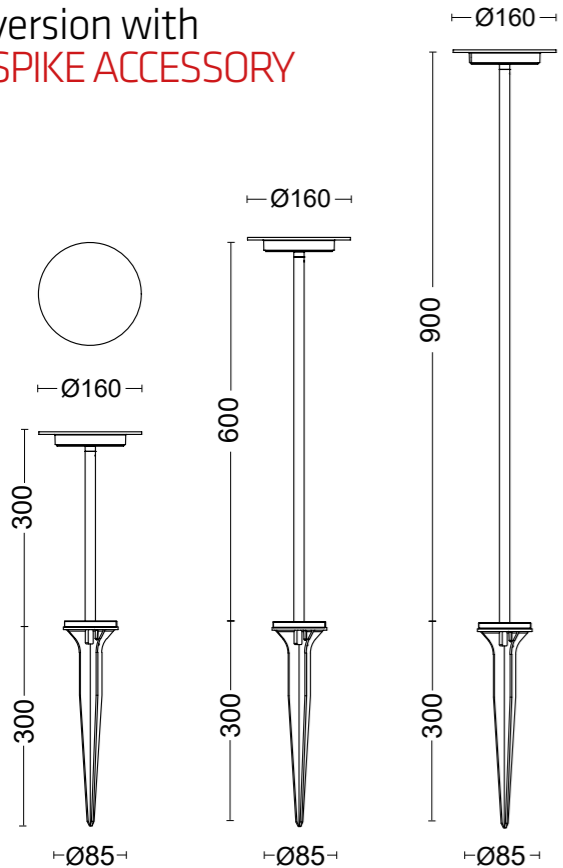

version with UNDERGROUND CASING ACCESSORY

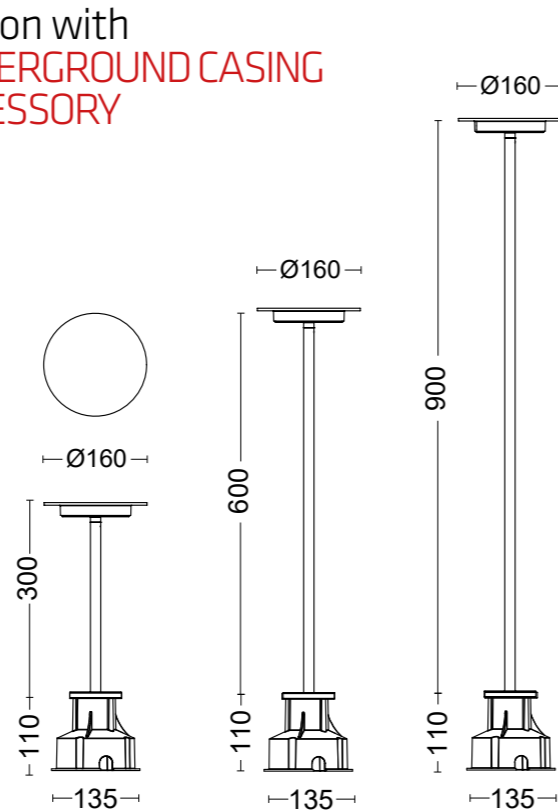

Versione in Tensione - Constant voltage (Vdc)

LED SYSTEM WITH REMOTE DRIVER 24V

code	beam	class	power	W	source	fixture	CCT LED	CRI
H 300 mm	DIFFUSE 360°	III	24Vdc	11W	1420 lm	800 lm	3000K	>80
H 600 mm	DIFFUSE 360°	III	24Vdc	11W	1510 lm	880 lm	4000K	>80
H 900 mm	DIFFUSE 360°	III	24Vdc	11W	1420 lm	800 lm	3000K	>80
H 900 mm	DIFFUSE 360°	III	24Vdc	11W	1510 lm	880 lm	4000K	>80
H 900 mm	DIFFUSE 360°	III	24Vdc	11W	1420 lm	800 lm	3000K	>80
H 900 mm	DIFFUSE 360°	III	24Vdc	11W	1510 lm	880 lm	4000K	>80

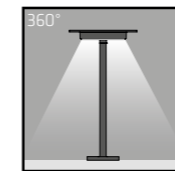

Accessories

informazioni sugli accessori sul nostro sito web
information about accessories on our website

SPIKE Underground CASING DRIVER 24Vdc / mA HUB for electronic parts

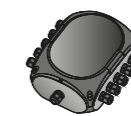
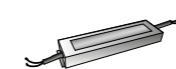
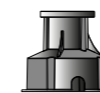

Specifications





STEM

collection



STEMS

collection



STEM

collection

STEM wall



Fixture Specifications

Protection . IP 65 - IK 08

Body . Anticorodal turning aluminum 6000 Serie, for greater corrosion resistance

Screen . Opal Polycarbonate

Seals . EPDM rubber

Screws . Stainless steel A2

Paint / Finishing . Anti-corrosive UV stabilised polyester powder

STEM WALL

led WHITE

Versione in Tensione - Constant voltage (Vdc)

code	beam	class	power	W	source	fixture	CCT LED	CRI
350W /WRRC	DIFFUSE 360°	III	24Vdc	11W	1420 lm	800 lm	3000K	>80
350W /NRRC	DIFFUSE 360°	III	24Vdc	11W	1510 lm	880 lm	4000K	>80

LED SYSTEM WITH REMOTE DRIVER 24V

Finishes

New Color

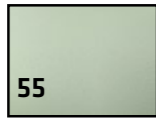

55
GREEN
COOL MINT
RAL 6019

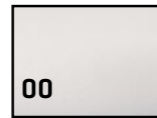

00
PURE WHITE
RAL 9016

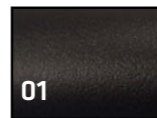

01
BLACK
RAL 9005



10
WHITE
RAL 9010

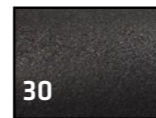

30
ANTHRACITE

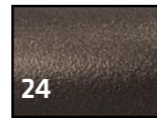

24
BRONZE

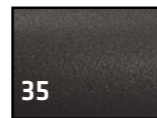

35
SLATE GREY

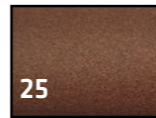

25
RUST



40
GREY
RAL 9006

Technical Data

EMISSIONE DIFFUSA 360° - DIFFUSE EMISSION 360°

3000K - 4000K

Versione in Tensione - Constant voltage (Vdc)

11 W con DRIVER REMOTO 24Vdc - 11 W REMOTE DRIVER 24Vdc

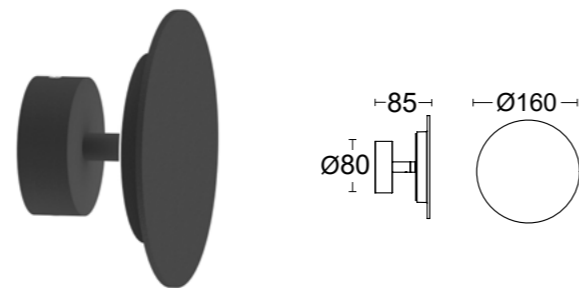

Quote espresse in millimetri "mm"
Share expressed in millimeters "mm"

Sizes . Ø160 x W85 x Ø base 80

Specifications



Accessories

informazioni sugli accessori sul nostro sito web
information about accessories on our website

DRIVER 24Vdc / mA

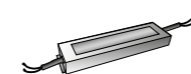

HUB for electronic parts

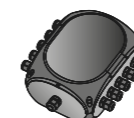

Specifications



STEM

collection





STEM
S
collection

STEM

GOOD

INSTALLATION

BY **Augenti**[®]
LIGHTING DESIGN



Augenti[®]

LIGHTING DESIGN

FRAMON GROUP



AUGENTI LIGHTING S.R.L. UNIPERSONALE

Via Francesco Lana, 31 - 25065 Lumezzane (BS) Italy - tel: (+39) 030 7282524 - fax: (+39) 030 7281879
info@augentilighting.it - www.augentilighting.it